

DIRECTED.

The company behind Clifford® Auto Security Systems is Directed.

Since its inception, Directed has had one purpose, to provide consumers with the finest vehicle security and accessories available. The recipient of nearly 100 patents and Innovations Awards in the field of advanced electronic technology.

Quality Directed products are sold and serviced throughout North America and around the world.

Call **(800) 876-0800** for more information about our products and services.

© 2013 Directed, All rights reserved.

QR65906X 2013 09

CLIFFORD
CLIFFORD
THE SCIENCE OF SECURITY™

Vista, CA 92081
www.clifford.com

Directed is committed to delivering world class quality products and services that excite and delight our customers.

OWNER'S GUIDE

M O D E L
5906X



Congratulations

Congratulations on the purchase of your state-of-the-art remote start and security system. Reading this Owner's Guide prior to using your system will help maximize the use of your system and its many features. For any additional questions please contact your authorized Directed dealer or contact Directed at 1-800-753-0600 (U.S. only).

Additional Guide Information

Only basic commands, features and essential information are covered in this compact guide. Your product has many advanced features which are not discussed here, please consult the expanded online version for these on the website listed on the back cover. Most sections in this guide also contain additional information which can be found in the expanded online version.

Government Regulations and Safety information



Read the *Government Regulations and Warning! Safety First* sections of this manual prior to operating this system.

Warning! Failure to heed this information can result in death, personal injury or property damage and may also result in the illegal use of the system beyond its intended purpose.

Your Warranty

Your system comes with a warranty. The warranty terms are detailed at the end of this guide. Make sure that you receive the proof of purchase from your dealer, indicating the product was installed by an authorized Directed dealer.

Replacement remote controls

Please see your authorized dealer or visit us at www.directedstore.com to order additional remote controls. Remote control part numbers are found on the back of the device.

Getting Started

Due to transit and storage time prior to your purchase, the battery charge may have depleted. To ensure proper operation, check the battery level and connect the included USB cable between it and a computer if not fully charged. The displayed battery level icon indicates when the battery is fully charged.

Contents

Remote Control Information.....	2
Control Center.....	3
Specifications.....	3
Status Screen Icons.....	4
Using your System.....	6
Commands and Confirmations.....	6
Navigation.....	6
Performing Commands.....	6
Fault Condition Alerts.....	7
Basic commands (function level 1).....	8
Arm.....	8
AUX/Trunk.....	8
Disarm.....	9
Remote Start.....	9
Configuring your System.....	10
Navigating menus and configuring features.....	10
1-way Companion Remote Control.....	12
Specifications.....	12
Battery Information (Responder HD).....	13
Battery Information (1-Way).....	13
Battery Disposal.....	13
Patent Information.....	14
Government Regulations.....	14
Warning! Safety First.....	16
Installation.....	16
Remote Start Capable.....	16
Manual Transmission Vehicles.....	16
Interference.....	18
Upgrades and Batteries.....	18
Water/Heat Resistance.....	18
Limited lifetime consumer warranty.....	19

Remote Control Information

Feature	Description
Internal Antenna *	Used for transmitting and receiving information
Display	Full color display
Command buttons (4): 	Used to perform arming, disarming, auxiliary channel and remote start commands
Menu wheel (located on side)	Used to access Function Level screens, control Status Screen info center content, and navigates the remote control and system configuration menus
Reset Button **	Resets the remote control's microprocessor
Mini USB Port	Used for charging the internal battery (not shown)

- * Avoid touching or grasping the area where the internal antenna is located as it may reduce range (the internal antenna is located above the display, towards the top).
- ** Should the remote stop responding to button presses, insert a pin or the end of a paper clip through the small hole on the remote control rear and press in on the reset button for one second.

Control Center



The Control Center, typically located on the upper part of the front windshield sends and receives commands or messages to and from your system. It consists of:

- The In-vehicle system antenna, for 2 way communication.
- The Status LED, as a visual indicator of the system's status.
- The Control button, for placing the system into Valet Mode* and to perform the Emergency Override** operation.

Specifications

Responder HD 2-way SST Remote Control

Power Requirements:	5 VDC, 500 mA
Display:	128 by 128 pixel, 65k, Color Organic Light Emitting Diode (OLED)
Frequency:	900 - 928 MHz Spread Spectrum
Operating Temperature:	-10°C to +40°C (23°F to 104°F)







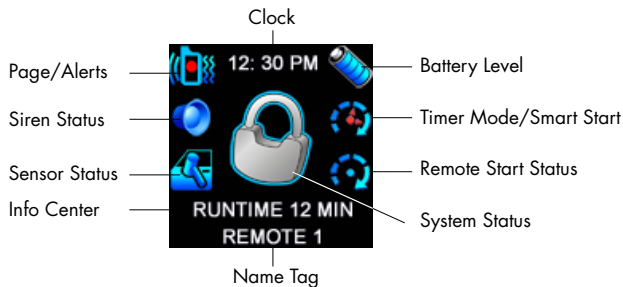

* See "Remote and System Operations" in online guide.













** See "Alarm Features" in online guide.

Status Screen Icons



The table below describes all the Status screen icons.

Feature	Description
Clock	Indicates the time in 12 or 24 hour format
Battery level	 Full ¾ ½ ¼ Empty
Timer Mode / Smart Start	 Timer Mode is enabled.  Smart Start is enabled.
Remote Start	 Remote start is active, the engine is running.  Manual Transmission Start mode is enabled, the engine can be started
System Status	 The system is armed, the alarm is enabled.  The system is disarmed, the alarm is disabled.  The system is Locked in Valet, the alarm is disabled.  The system is Unlocked in Valet, the alarm is disabled. Second system operation: If set to control a second system, the above lock icons will contain a "2".

Feature	Description
Name Tag	Displays a personalized name tag 1-15 characters long
Info Center	Displays the Remote Start runtime, Temperature Auto-report, Parking meter and Countdown timers. While Status screen is on, press the menu wheel to change the displayed information.
Sensor Status	 Trigger Zones are enabled and functioning normally.
	 Trigger zone fault found when arming and is bypassed.
	 NPC On, a sensor has triggered excessively and is bypassed
	 Remote Sensor bypass On, the bypassed sensor will not trigger the alarm.
Siren Status	 Siren is enabled and will sound for all alarm outputs.
	 Siren is disabled for sensor triggers, remote is paged for all triggers (Sensor Silent Arm).
	 Siren is disabled for all triggers, remote is paged for all triggers (Full Silent Arm).
Page/Alerts	 Pager On,  Pager Off.
	 Battery Save On (Red dot), Battery Save Off (No dot).
	 Tone On (icon is not present when Tone is Off).
	 Vibrate On (icon is not present when Vibrate is Off).
	Example  Page Off, Vibrate On & Tone On.
	Varying combinations of these icons reflect the Paging and Alert Types menu settings.

Using your System

Commands and Confirmations

Commands, Basic or Advanced, are used to activate system features and are performed by pressing one of the Command buttons. Basic commands control the most often used security and remote start features while Advanced commands control more specialized features and request reports.

Confirmations for Basic or Advanced commands are indicated first by siren chirps and vehicle light flashes, and then as animations, still screens and beeps or tones on the remote control. A description of each feature confirmation is found in the following Basic commands section with the Advanced commands section found online.

Navigation

To navigate to the Status and Function level screens, **toggle** the menu wheel up or down, the screens will cycle as shown in the facing diagram. These screens remain displayed for 3 seconds before reverting to a blank screen. To display a screen for an extended 20 second period; **toggle** and **hold** the menu wheel on the desired screen for this duration, after which the display reverts to a blank screen.

Performing Commands

Perform Basic commands by pressing one of the command buttons while the remote control display is blank or the Status screen is On. Perform Advanced commands by pressing one of the command buttons while a Function Level screen is displayed.

Advanced command example: Silent Arm

1. **Toggle** the menu wheel to display the [Function Level 2](#) screen.

2. Press the  button while this screen is still on to perform the Silent Arm command.
3. The Responder HD remote will play the **SILENT ARM** animation followed by the Status screen.

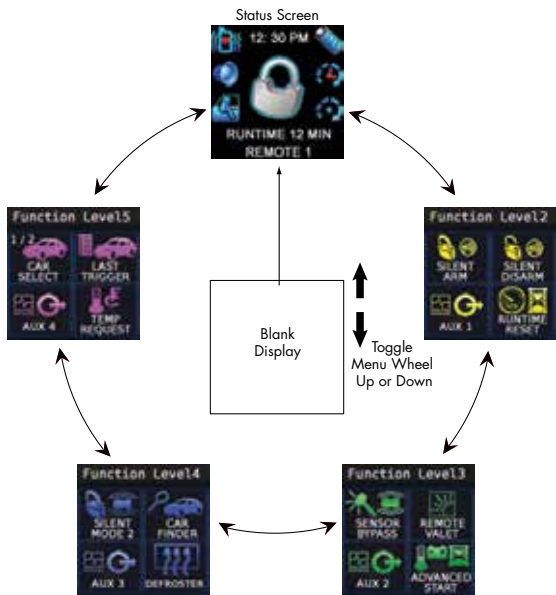

Fault Condition Alerts

If, when performing a command, a condition exists that does not allow the activation of a feature, a fault screen and tone plays as an alert. For more details on the condition and possible resolutions, use the fault screen title and locate the respective section through the table of contents.

Basic commands (function level 1)

Arm



Press and release 

The alarm arms, doors lock (if connected), and the siren chirps and lights flash once. The **ARMED** animation and beeps play to confirm. If Valet mode* is On the doors lock and the **LOCKED (IN VALET)** animation and tone play. Exit Valet mode to arm the alarm normally.

If a trigger zone fault is detected the siren chirps once again and the Trigger Zone Fault report** plays.

To Arm and Panic

Press and hold 

The alarm Arms (or Locks in Valet) and, after 2 seconds, sounds the siren and flashes the lights. The **PANIC** animation and siren tones play to confirm. Press the  or  button to stop the output.

AUX/Trunk

Press and hold 

The Trunk opens (if connected) when this button is pressed for 2 seconds. The **TRUNK RELEASE** animation and tones play to confirm.

Disarm

Press and release



The alarm disarms, doors unlock (if connected), and the siren chirps and lights flash twice. The **DISARM** animation and beeps play to confirm. If Valet mode* is On the doors unlock and the **UNLOCK (IN VALET)** animation and tone play.

More than 2 siren chirps and remote beeps indicates a trigger has occurred. The Disarm animation is then replaced by the Alarm Trigger report.**

Remote Start

Press and release



Activates (or if On, deactivates) the remote starter. The engine and lights turn On and the **REMOTE START ACTIVATED** animation and On tones play, or the engine and lights turn Off and the **REMOTE START DEACTIVATED** animation and Off tones play to confirm. The Remote Start status icons in the Status screen are updated accordingly. If Remote Start fails to activate, a fault screen and tone plays to identify the reason.***

* See "Remote and System Operations" in online guide.

** See "Alarm Features" in online guide.

*** See "Remote Start Not Available" in online guide.

For Manual transmission vehicles see the "Manual Transmission Start (MTS mode)" in online guide.

Configuring your System

You can customize the way the HD remote communicates information and adjust a variety of system features in the [Settings](#), [Adjustments](#) and [Options](#) configuration menus. The following features are listed and defined in the same sequential order as they appear on your system.

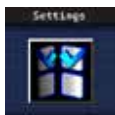

Button Auto Lock
Alert Types
Animations
Button Beeps
Paging
Temp Units

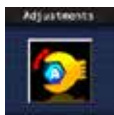

Clock Settings
Timer Start
Smart Start
Remote Pair
Sensor Adjust

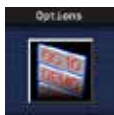

Power Off
Parking Meter
Countdown Timer
Name Tags
Demo Mode
Level 5 screen



No features, used
only to exit menus

Navigating menus and configuring features

Configuring your system is performed via the menu wheel and command buttons.

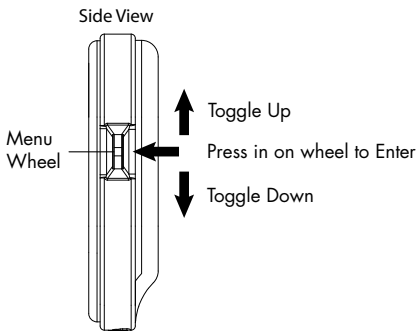

The following instructions discuss how to access and configure the many features available, allowing you to customize your HD remote control to your personal preferences.

To access the main menu screens (from a blank display):

1. **Press** and **hold** the menu wheel for 3 seconds, the remote control enters the main menu and displays the **Settings** screen.
2. **Toggle** the menu wheel to scroll through the **Settings**, **Options**, **Adjustments** and **Exit** main menu screens.
3. **Press** the menu wheel to enter a displayed main menu.
4. **Toggle** the menu wheel to highlight a menu item.
5. **Press** the menu wheel to access the menu item screen.

Making selections, go back and exit:





6. **Toggle** the menu wheel to move the highlight to the desired configuration and then **press** to set. The selected configuration is indicated by the pointer on the right. Continue to **hold** the menu wheel to return to normal operation or **release** to remain within the menu. Highlight **Back** and **press** to return to the previous menu or continue **holding** to return to normal operation.

Adjust timers and features

7. When adjustment screens are accessed, the current settings are displayed. **Toggle** the menu wheel to highlight a settings field and then **press** it to adjust the setting. Follow the on-screen instructions or the description in each feature section to adjust the feature settings.

Menus are automatically exited after a 30 second lapse in button activity.

1-way Companion Remote Control

	Basic Commands	Advanced Commands			
	(Function Level 1)	Function Level 2	Function Level 3	Function Level 4	Function Level 5
Level Button	Direct Access	f x 1	f x 2	f x 3	f x 4
	Arm/Lock (Panic)	Silent Arm	Sensor Bypass	Sensor Silent Mode	Full Silent Mode*
	Disarm/Unlock	Silent Disarm	Remote Valet	Car Finder	
	Remote Start	Runtime Reset	Timer Mode*	Smart Start*	Defroster*
	Aux/Trunk	AUX 1	AUX 2	AUX 3	AUX 4
f	Not Used	Used to access function levels for Advanced Commands (f with multiplier in third row implies button presses)			

* These Function Level commands on the 1-way do not reside in the exact same Function Level location as on the HD remote control.

Specifications

1-way SST Remote Control

Power Requirements: 3 VDC, CR2032 Coin Cell Battery

Frequency: 900 MHz

Operating Temperature: -10°C to +40°C (23°F to 104°F)

Battery Information (Responder HD)

The Responder HD remote control is powered by an internal rechargeable battery that can be serviced only through an authorized Directed dealer.



Warning! When charging, NEVER use a cable other than the one provided or plug into an unspecified source. Injury, severe damage or explosion may occur when connected to any other products or used in a way not intended.

Battery Information (1-Way)

The 1-way companion remote is powered by one 3V coin cell lithium battery (P/N CR-2032) that should last approximately one year under normal use.

Battery Disposal



Directed cares about the environment. If you need to dispose of the battery, please do so in accordance with your municipal requirements for battery disposal.

Patent Information

This product is covered by one or more of the following United States patents:

Remote Start Patents:

5,349,931; 5,872,519; 5,914,667; 5,952,933; 5,945,936;
5,990,786; 6,028,372; 6,467,448; 6,561,151; 7,191,053;
7,483,783

Vehicle Security Patents:

5,467,070; 5,532,670; 5,534,845; 5,563,576; 5,646,591;
5,650,774; 5,673,017; 5,712,638; 5,872,519; 5,914,667;
5,952,933; 5,945,936; 5,990,786; 6,028,505; 6,452,484

Other patents pending.

Government Regulations

This device complies with Part 15 of FCC rules. Operation is subject to the following two conditions: (1) This device may not cause harmful interference, and (2) This device must accept any interference received, including interference that may cause undesirable operation.

This equipment has been tested and found to comply with the limits for a class B digital device, pursuant to Part 15 of the FCC Rules. These limits are designed to provide reasonable protection against harmful interference in a residential installation. This equipment generates and can radiate radio frequency energy and, if not installed and used in accordance with the instruction manual, may cause harmful interference to radio communications. However, there is no guarantee that interference will not occur in a particular installation. If this equipment does cause harmful interference to radio or television, which can be

determined by turning the equipment OFF and ON, the user is encouraged to try to correct the interference by one or more of the following measures:

- Reorient or relocate the receiving antenna.
- Increase the separation between the equipment and receiver.
- Connect the equipment into an outlet on a circuit different from that to which the receiver is connected.
- Consult the dealer or an experienced radio / TV technician for help.

Remote Controls

To satisfy FCC RF exposure compliance requirements, this device should be used in hand-held, hand operated configurations only. The device and its antenna must maintain a separation distance of 20 cm or more from the person's body, except for the hand and wrists, to satisfy RF exposure compliance. This device is designed to be used in a person's hands and its operating configurations do not support normal transmissions while it is carried in pockets or holsters next to a person's body.

Control Center

To satisfy FCC RF exposure compliance requirements, the device and its antenna must maintain a separation distance of 20 cm or more from the person's body, except for the hand and wrists, to satisfy RF exposure compliance.

This device complies with the Industry Canada Radio Standards Specification RSS 210. Its use is authorized only on a no-interference, no-protection basis; in other words, this device must not be used if it is determined that it causes harmful interference to services authorized by IC. In addition, the user of this device must accept any radio interference that may be received, even if this interference could affect the operation of the device.

WARNING! Changes or modifications not expressly approved by the party responsible for compliance could void the user's authority to operate this device.

Warning! Safety First



Please read the safety warnings below before proceeding. Improper use of the product may be dangerous or illegal.

Installation

Due to the complexity of this system, installation of this product must only be performed by an authorized Directed dealer. If you have any questions, ask your retailer or contact Directed directly at 1-800-753-0600.

Remote Start Capable

When properly installed, this system can start the vehicle via a command signal from the remote control transmitter. Therefore, never operate the system in an enclosed area or partially enclosed area without ventilation (such as a garage). When parking in an enclosed or partially enclosed area or when having the vehicle serviced, the remote start system must be disabled using the installed menu wheel. It is the user's sole responsibility to properly handle and keep out of reach from children all remote control transmitters to assure that the system does not unintentionally remote start the vehicle. THE USER MUST INSTALL A CARBON MONOXIDE DETECTOR IN OR ABOUT THE LIVING AREA ADJACENT TO THE VEHICLE. ALL DOORS LEADING FROM ADJACENT LIVING AREAS TO THE ENCLOSED OR PARTIALLY ENCLOSED VEHICLE STORAGE AREA MUST AT ALL TIMES REMAIN CLOSED. These precautions are the sole responsibility of the user.

Manual Transmission Vehicles

Remote starters on manual transmission vehicles operate differently than those with automatic transmission because you must leave your car in neutral. You must read this Owner's Guide to familiarize yourself with the proper procedures regarding manual transmission remote starters. If you have any questions, ask your authorized Directed dealer or contact Directed at 1-800-753-0600.

Before remote starting a manual transmission vehicle, be sure to:

- Leave the vehicle in neutral and be sure no one is standing in front or behind the vehicle.
- Only remote start on a flat surface
- Have the parking brake fully engaged

WARNING! It is the responsibility of the owner to ensure the parking/emergency brake properly functions. Failure to do so can result in personal injury or property damage. We recommend the owner have the parking / emergency brake system inspected and adjusted by a qualified automotive shop biannually.

Use of this product in a manner contrary to its intended mode of operation may result in property damage, personal injury, or death. (1) Never remotely start the vehicle with the vehicle in gear, and (2) Never remotely start the vehicle with the keys in the ignition. The user must also have the neutral safety feature of the vehicle periodically checked, wherein the vehicle must not remotely start while the car is in gear. This testing should be performed by an authorized Directed dealer in accordance with the Safety Check outlined in the product installation guide. If the vehicle starts in gear, cease remote start operation immediately and consult with the authorized Directed dealer to fix the problem.

After the remote start module has been installed, contact your authorized dealer to have him or her test the remote start module by performing the Safety Check outlined in the product installation guide. If the vehicle starts when performing the Neutral Safety Shutdown Circuit test, the remote start unit has not been properly installed. The remote start module must be removed or the installer must properly reinstall the remote start system so that the vehicle does not start in gear. All installations must be performed by an authorized Directed dealer.

OPERATION OF THE REMOTE START MODULE IF THE VEHICLE STARTS IN

GEAR IS CONTRARY TO ITS INTENDED MODE OF OPERATION. OPERATING THE REMOTE START SYSTEM UNDER THESE CONDITIONS MAY RESULT IN PROPERTY DAMAGE OR PERSONAL INJURY. YOU MUST IMMEDIATELY CEASE THE USE OF THE UNIT AND SEEK THE ASSISTANCE OF AN AUTHORIZED Directed DEALER TO REPAIR OR DISCONNECT THE INSTALLED REMOTE START MODULE. DIRECTED WILL NOT BE HELD RESPONSIBLE OR PAY FOR INSTALLATION OR REINSTALLATION COSTS.

This product is designed for fuel injected vehicles only. Use of this product in a standard transmission vehicle must be in strict accordance with this guide.

This product should not be installed in any convertible vehicles, soft or hard top with a manual transmission. Installation in such vehicles may pose certain risk.

Interference

All radio devices are subject to interference which could affect proper performance.

Upgrades and Batteries

Any upgrades to this product and/or installation of batteries must be performed by an authorized dealer. Do not attempt to perform any unauthorized modifications to this product.

Water/Heat Resistance

This product is not designed to be water and/or heat-resistant. Please take care to keep this product dry and away from heat sources. Any damage from water or heat will void the warranty.

Limited lifetime consumer warranty

Directed Electronics. ("Directed") promises to the original purchaser to repair or replace (at Directed's election) with a comparable reconditioned model any Directed unit (hereafter the "unit"), excluding without limitation the siren, the remote transmitters, the associated sensors and accessories, which proves to be defective in workmanship or material under reasonable use during the lifetime of the vehicle provided the following conditions are met: the unit was purchased from an authorized Directed dealer, the unit was professionally installed and serviced by an authorized Directed dealer; the unit will be professionally reinstalled in the vehicle in which it was originally installed by an authorized Directed dealer; and the unit is returned to Directed, shipping prepaid with a legible copy of the bill of sale or other dated proof of purchase bearing the following information: consumer's name, telephone number and address; the authorized dealers name, telephone number and address; complete product description, including accessories; the year, make and model of the vehicle; vehicle license number and vehicle identification number. All components other than the unit, including without limitation the siren, the remote transmitters and the associated sensors and accessories, carry a one-year warranty from the date of purchase of the same. ALL PRODUCTS RECEIVED BY DIRECTED FOR WARRANTY REPAIR WITHOUT PROOF OF PURCHASE FROM AN AUTHORIZED DEALER WILL BE DENIED. This warranty is non-transferable and is automatically void if: the unit's date code or serial number is defaced, missing or altered; the unit has been modified or used in a manner contrary to its intended purpose; the unit has been damaged by accident, unreasonable use, neglect, improper service, installation or other causes not arising out of defects in materials or construction. The warranty does not cover damage to the unit caused by installation or removal of the unit. Directed, in its sole discretion, will determine what constitutes excessive damage and may refuse the return of any unit with excessive damage. TO THE MAXIMUM EXTENT ALLOWED BY LAW, ALL WARRANTIES, INCLUDING BUT NOT LIMITED TO EXPRESS WARRANTY, IMPLIED WARRANTY, WARRANTY OF MERCHANTABILITY, FITNESS FOR PARTICULAR PURPOSE AND WARRANTY OF NON-INFRINGEMENT OF INTELLECTUAL PROPERTY, ARE EXPRESSLY EXCLUDED; AND DIRECTED NEITHER ASSUMES NOR AUTHORIZES ANY PERSON OR ENTITY TO ASSUME FOR IT ANY DUTY, OBLIGATION OR LIABILITY IN CONNECTION WITH ITS PRODUCTS. DIRECTED DISCLAIMS AND HAS ABSOLUTELY NO LIABILITY FOR ANY AND ALL ACTS OF THIRD PARTIES INCLUDING ITS AUTHORIZED DEALERS OR INSTALLERS. DIRECTED SECURITY SYSTEMS, INCLUDING THIS UNIT, ARE DETERRENTS AGAINST POSSIBLE THEFT. DIRECTED IS NOT OFFERING A GUARANTEE OR INSURANCE AGAINST VANDALISM, DAMAGE OR THEFT OF THE AUTOMOBILE, ITS PARTS OR CONTENTS; AND HEREBY EXPRESSLY DISCLAIMS ANY LIABILITY WHATSOEVER, INCLUDING WITHOUT LIMITATION, LIABILITY FOR THEFT, DAMAGE AND/OR VANDALISM. THIS WARRANTY DOES NOT COVER LABOR COSTS FOR MAINTENANCE, REMOVAL OR REINSTALLATION OF THE UNIT OR

ANY CONSEQUENTIAL DAMAGES OF ANY KIND. IN THE EVENT OF A CLAIM OR A DISPUTE INVOLVING DIRECTED OR ITS SUBSIDIARY, THE VENUE SHALL BE SAN DIEGO COUNTY IN THE STATE OF CALIFORNIA. CALIFORNIA STATE LAWS AND APPLICABLE FEDERAL LAWS SHALL APPLY AND GOVERN THE DISPUTE. THE MAXIMUM RECOVERY UNDER ANY CLAIM AGAINST DIRECTED SHALL BE STRICTLY LIMITED TO THE AUTHORIZED DIRECTED DEALER'S PURCHASE PRICE OF THE UNIT. DIRECTED SHALL NOT BE RESPONSIBLE FOR ANY DAMAGES WHATSOEVER, INCLUDING BUT NOT LIMITED TO, ANY CONSEQUENTIAL DAMAGES, INCIDENTAL DAMAGES, DAMAGE TO VEHICLE, DAMAGES FOR THE LOSS OF TIME, LOSS OF EARNINGS, COMMERCIAL LOSS, LOSS OF ECONOMIC OPPORTUNITY AND THE LIKE. NOTWITHSTANDING THE ABOVE, THE MANUFACTURER DOES OFFER A LIMITED WARRANTY TO REPLACE OR REPAIR THE CONTROL MODULE SUBJECT TO THE CONDITIONS AS DESCRIBED HEREIN. THIS WARRANTY IS VOID IF THE UNIT HAS NOT BEEN PURCHASED FROM DIRECTED, OR AN AUTHORIZED DIRECTED DEALER, OR IF THE UNIT HAS BEEN DAMAGED BY ACCIDENT, UNREASONABLE USE, NEGLIGENCE, ACTS OF GOD, NEGLIGENCE, IMPROPER SERVICE, OR OTHER CAUSES NOT ARISING OUT OF DEFECT IN MATERIALS OR CONSTRUCTION.

Some states do not allow limitations on how long an implied warranty will last or the exclusion or limitation of incidental or consequential damages. This warranty gives you specific legal rights and you may also have other rights that vary from State to State.

This warranty is only valid for sale of product(s) within the United States of America and in Canada. Product(s) sold outside of the United States of America or Canada are sold "AS-IS" and shall have NO WARRANTY, express or implied.

For further details relating to warranty information of Directed products, please visit the support section of Directed's website at: www.directed.com

This product may be covered by a Guaranteed Protection Plan ("GPP"). See your authorized Directed dealer for details of the plan or call Directed Customer Service at 1-800-876-0800.